



SINCE 1953

Fu Sheng Industrial Co., Ltd.

POWERATE

ENGINEERING CO., LTD.

บริษัท พาวเวอร์เอร์เรท เอ็นจิเนียริ่ง จำกัด

35/356 หมู่ 2 ถ.เอกชัย ต.บางน้ำจืด อ.เมือง จ.สมุทรสาคร 74000

Tel. 034-494-668 (Auto) Fax. 034-494-669

ออฟฟิศกรุงเทพฯ : Tel. 02-750-2767-8 Fax. 02-750-2769

www.powerate-th.com E-mail : master@powerate-th.com

Screw Air Compressor

75~600HP 7~15kg/cm²G



ISO9001
BCIQ



SINCE 1953

FU SHENG INDUSTRIAL CO., LTD.

World Class Product - Fu Sheng Screw Air Compressor

Precision, Low Noise, Safety, Low Maintenance Cost & Low Operation Cost



Honored with the Symbol of Excellence of Taiwan
Screw rotor profile has been granted the U.S patent NO4.890.992.
U.K patent G.B.2230563B

Maximizing energy savings with the third generation screw stages:

- Asymmetric profile with 5-lobe male rotors and 6 flute female rotors.
- Reduced differential pressure between flutes helps decrease backflow, thus, increases adiabatic efficiency by 10~12% and energy savings by 25% as compared with the 4 to 6 profile design.
- Casing and bearing seats are integral parts and machined in the same sequence to achieve high precision and to minimize clearances.
- A bearing design life of 50,000 hours can be assured by the specially designed short rotors with minimum vibration and bending stress.
- Rotors revolve at low speed; thus, low noise level can be guaranteed.
- A wide pressure ranging from 4 to 15 kg/cm²G suits various needs.

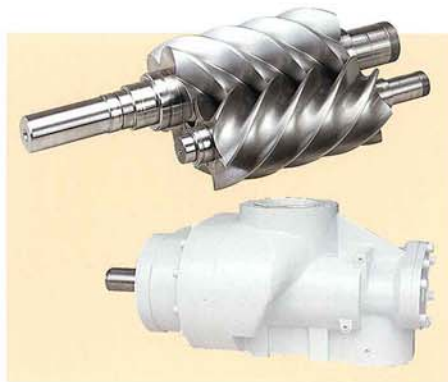

Flow Chart Diagram (SA5150W II SA5350W II)

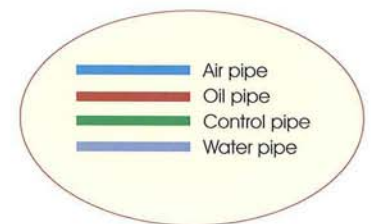
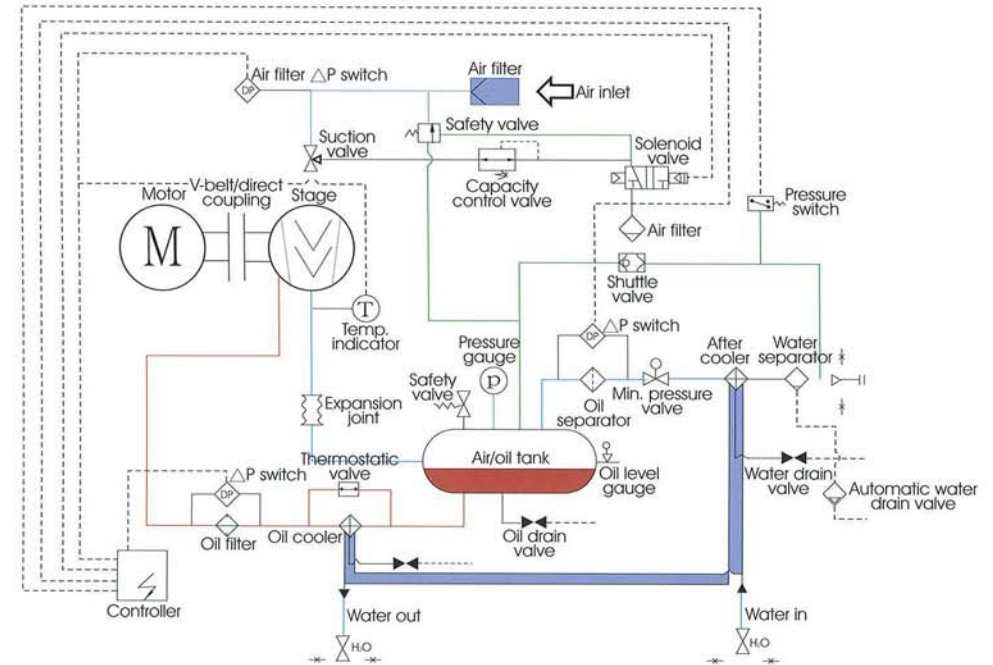

Planning new compressors correctly Help you save your money

Operation pressure:

1. The higher operating pressure the more power is needed. The minimum operating pressure is the working pressure plus the piping loss. Selection of adequate pipe dimension and arrangement should be taken into account.
2. List all pressures you need to select compressor. If pressure differential is too big, compressors with different working pressures or boosters should be used. Do not regulate to lower pressure from high discharge pressure of compressors. It will waste energy.

Site selection:

1. Select wide and bright location for easy maintenance.
2. Choose low humidity, less dust, clean air and good ventilation area with room temperature lower than 40°C.

Cooling water:

1. Low cooling water temperature. is preferred. The application of cooling tower is recommended.

2. Pay special attention to the PH factor of cooling water. It should be kept around 7.0 to prevent the scale from clogging the copper tube, thus to save the maintenance expense.
3. Pay attention to the proper functioning of heat exchanger. Generally speaking, the air outlet temp. of air compressor should be about 40~45°C.

Model selection:

1. Air delivery shown on our catalog can be justified as per ASME code.
2. Add some allowance to the actual consumption you calculate.
3. Pay attention to the specific power consumption of the compressor to save the energy.

The quality and requirement of compressed air:

The compressed air before condensation contains saturated water vapor which will hurt the precision Instruments, pneumatic equipment, instrumentation, piping, etc. For fear of corrosion, clog, low air quality, damage to apparatus and increased maintenance cost, it is necessary to install an air filtration system as shown below :

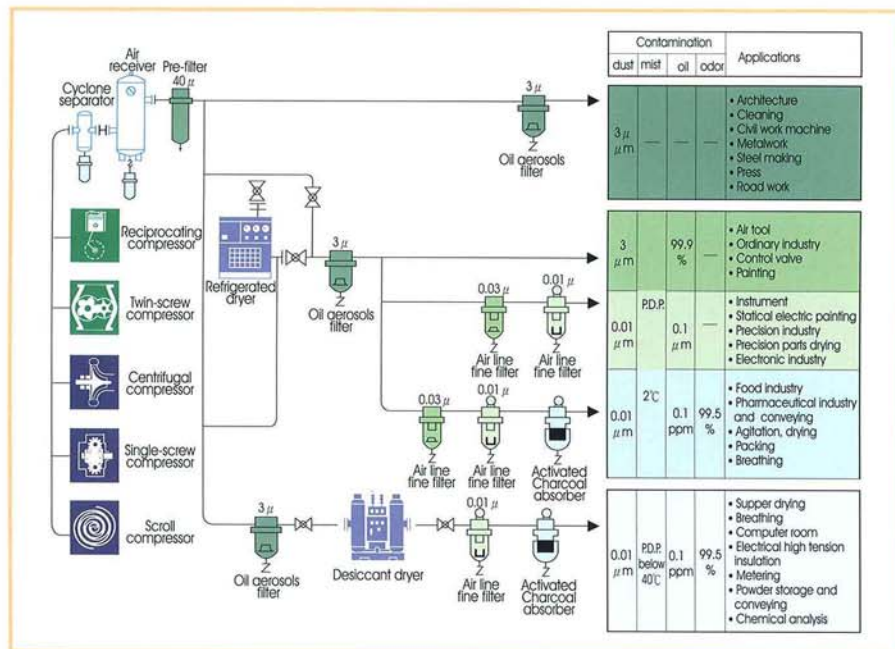

SA-5 Series Screw Air Compressor

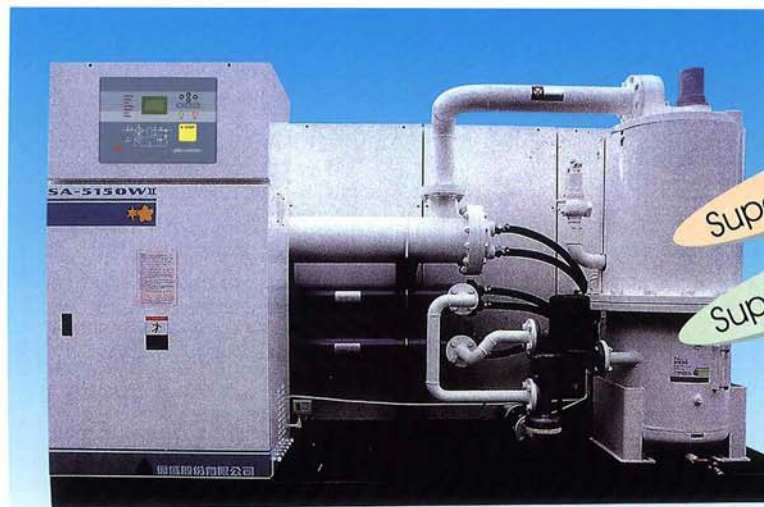

Superb Efficiency
Superb Low Noise

- *The half disclosure design insulates the noise from the air end but leaves other parts open for easy maintenance.
- *The fin-type after-cooler with large piping diameter makes the repairing and maintaining job fast and easy.
- *The unique design has been applied to the oil/air tank and makes the installation and replacement of an oil separator very convenient.
- *Other features include anti-vibration, NEMA 12 control panel, common base designs, etc.

Oil injection screw compressor specifications:

Model No.		SA-475WII	SA-4100WII	SA-4125WII	SA-5150WII	SA-5175WII	SA-5200WII	SA-5250WII	SA-5300WII
Compress- or Stage	Stage No.	SA-4G			SA-5		SA-5G		
	Working pressure	Kg/cm ² G 7							
Main driver	Delivery	10.5	14	16.5	21	26	29	35	42
	Horsepower	75	100	125	150	175	200	250	300
	Starting method	Y-Δ Starter				Y-Δ Starter or Reactor Starter			
Pipe di- ameter	Voltage	220/380/440/3300							
	Frequency	60/50							
Dimension	Air outlet	in 2	2	2	4	4	4	4	4
	Water inlet/outlet	in 1 1/2	1 1/2	1 1/2	2	2	2	2	2
	Length	2000		2916		2916		3036	
	Width	1400		2008		2008		2106	
	Height	1700		1700		1700		2106	
	Net Weight	2300	2500	2800	3500	4500	5800		

- *Working pressure ranged from 7 to 15 kg/cm²G. For other working pressure, please contact us.
- *350HP~600HP models are also available. Please contact us for air-cooled models.
- * (A) : Air-cooled models, (W) : Water-cooled models.
- *The specifications are subject to change without notification.

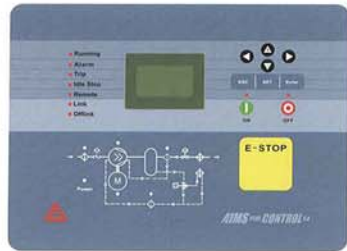

- CONTROLLER CHARACTERISTICS:**
1. Simple and intelligent interface for ease of operation.
 2. Real time compressor status displayed with LCD display and LED indicator.
 3. Remote start/stop control.
 4. Recording all interruption/malfunction data for ease of maintenance.
 5. Automatic start/stop function. Automatic re-start following power outage.
 6. Password protection against unauthorized manipulation.
 7. Optional Function: Capacity of sequencer Control Mode for maximum 16 machines. (External sequencer is unnecessary).
 8. MODBUS conventional communication with capability of connecting to all type of central monitoring system.
 9. 20 entries alarm/trip history.
 10. Warning for consumable product replacement. (Detail record for periodical replacement and maintenance information)

Energy saving capacity control

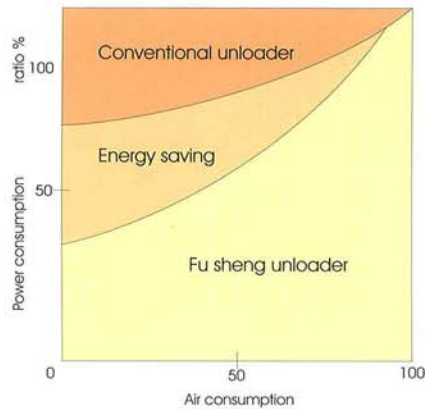

Oil fine separator
 • Controls oil particle size to 0.1 um and oil carry-over lower than 3 ppm. Excellent separation ensures long service life.



Thermostatic valve
 • To control oil temp. between 67-72°C which ensures the Discharge temp. above the dew point to avoid oil emulsification and protect rotors and bearings from damage.



Oil filter
 • High quality oil filter to filter alien particles in oil, e.g. Metal particles.



Air-cooled cooler

High efficient cooler
 • Low temperature difference design of cooler is suitable For all kinds of circumstances.

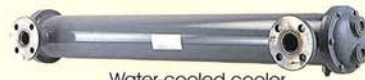

Water-cooled cooler



Modulation suction valve
 • It will precisely control air capacity to reduce horsepower consumption and save energy.

Fu Sheng Products The Logical Choice in Today's Environment:

Fu Sheng has over 45 years of experience in compressor manufacturing. With the technical know-how accumulated through its innovative history, the company has developed the third generation twin screw compressors to completely meet all requirements. The applications for the twin screw rotary compressor have been increasing rapidly and they are now designed to serve such diverse industries as the medical, food processing, office and electronic fields. The compressors are, therefore, required to meet a high standard of quality and increased performance criteria, such as high durability, low noise, minimal vibration, easy maintenance and service, safe operation, compactness and economy.



▲ CNC Machining Centers



▲ Automatic Storage & Retrieval System



▲ CAD - CAM System



▲ Rotor Grinding Machine



▲ Clean Assembly Room



▲ Automatic Guided Vehicle



▲ Coordinate Measuring Machine